



## UJEŹDŹALNIE I STAJNIE DLA KONI



**STAL - E DO PRZODU**

[www.rolstal.com](http://www.rolstal.com)

# KONSTRUKCJE STALOWE UJEŹDŹALNI I STAJNI KLASYCZNYCH

## Ujeżdżalnia

## Projekt konstrukcyjny typu B

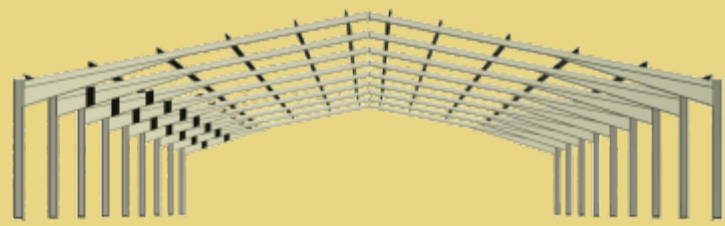
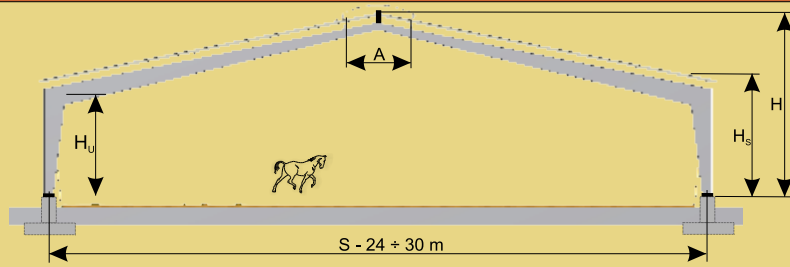

## Ujeżdżalnia

## Projekt konstrukcyjny typu H

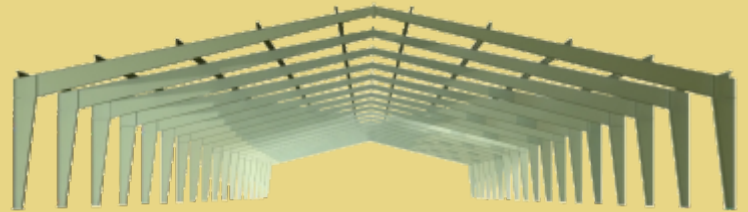
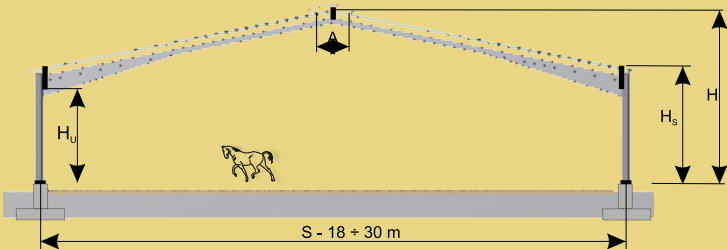

## Ujeżdżalnia

## Projekt konstrukcyjny typu K

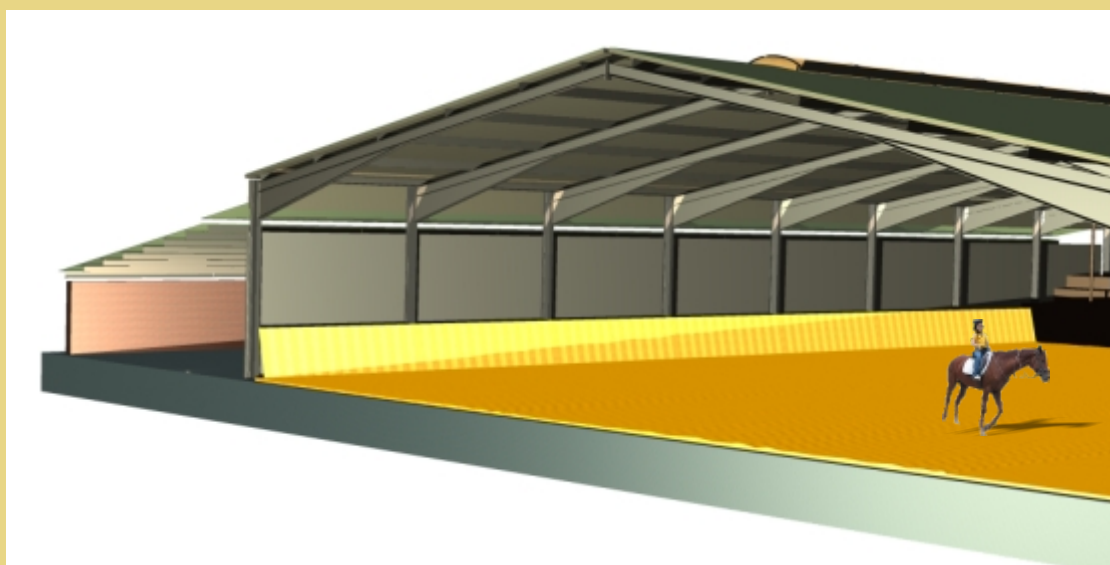
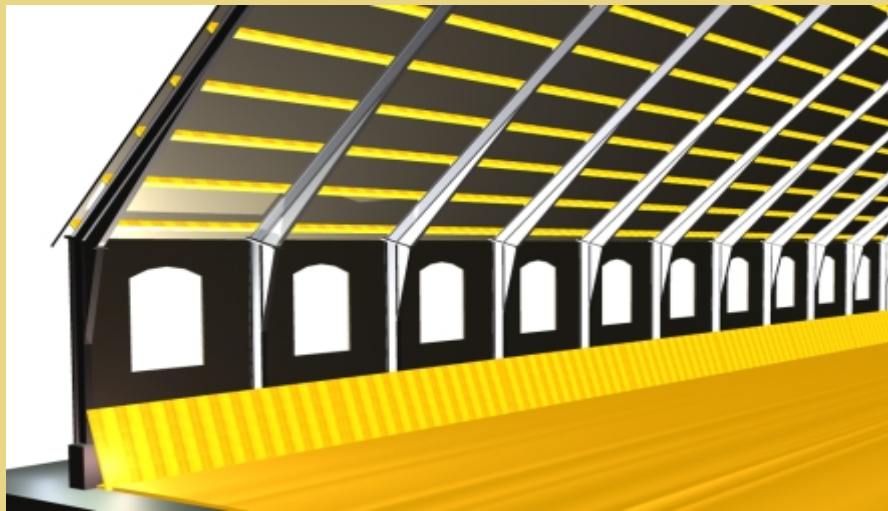
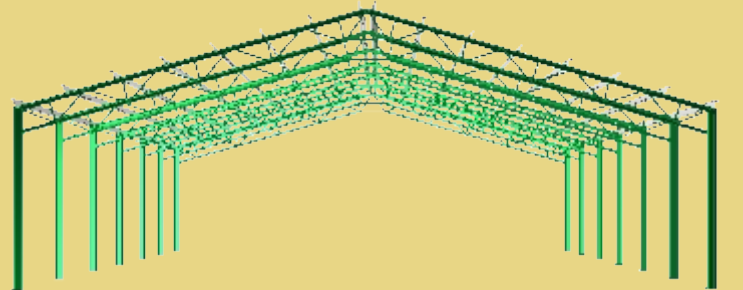
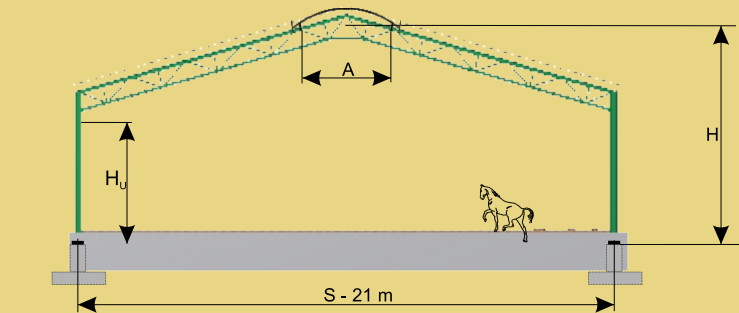

# KONSTRUKCJE STALOWE UJEŹDŹALNI I STAJNI KLASYCZNYCH



**Ujeżdżalnia**

**Projekt konstrukcyjny indywidualny**

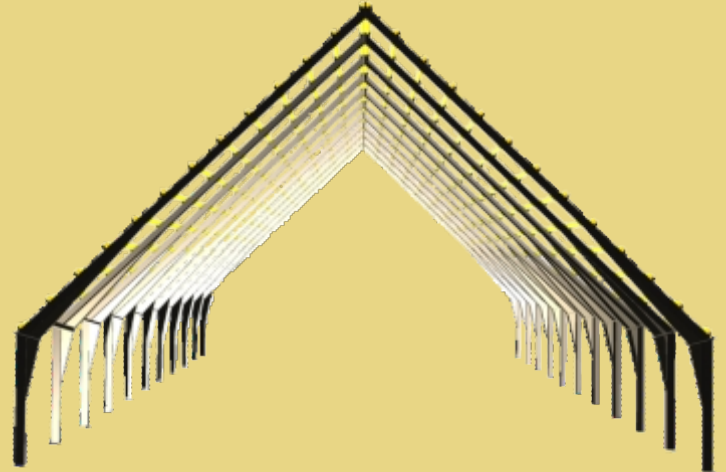
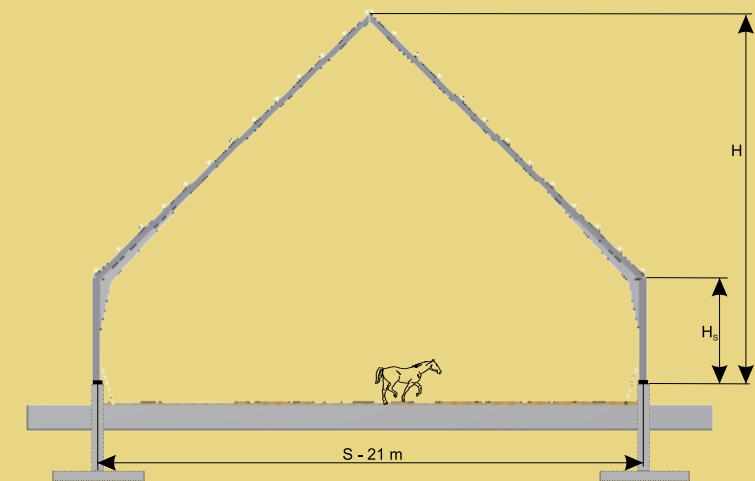

**Ujeżdżalnia ze stajnią**

**Projekt konstrukcyjny typu H2**

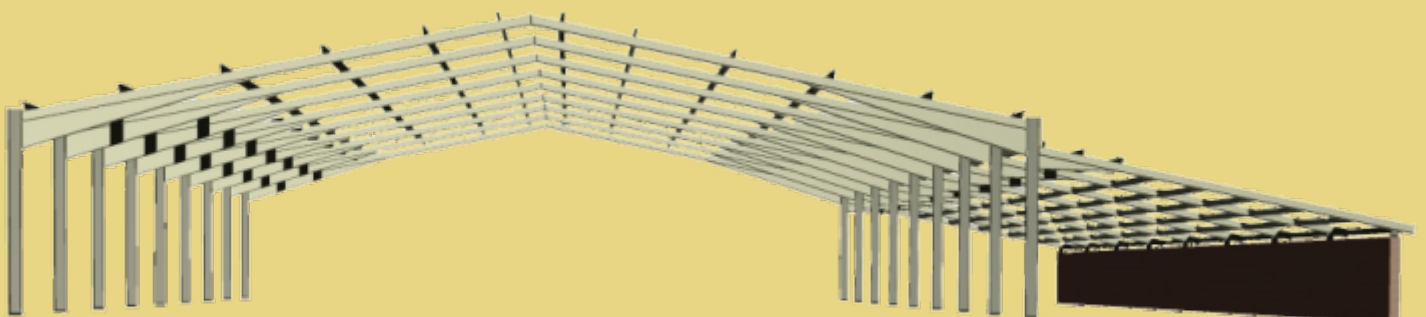

# KONSTRUKCJE STALOWE UJEŹDŹALNI I STAJNI KLASYCZNYCH

## Ujeżdżalnia ze stajnią

## Projekt konstrukcyjny typu H3

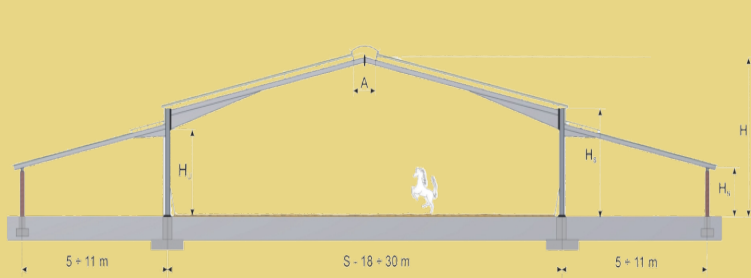

## Stajnia dwurzędowa

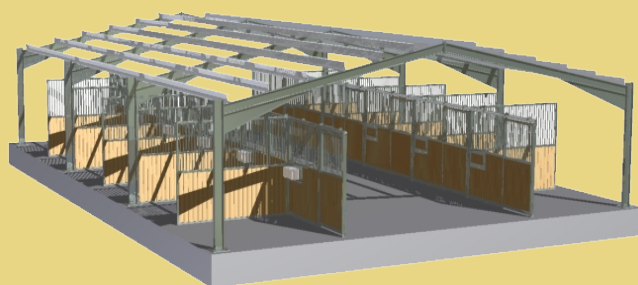
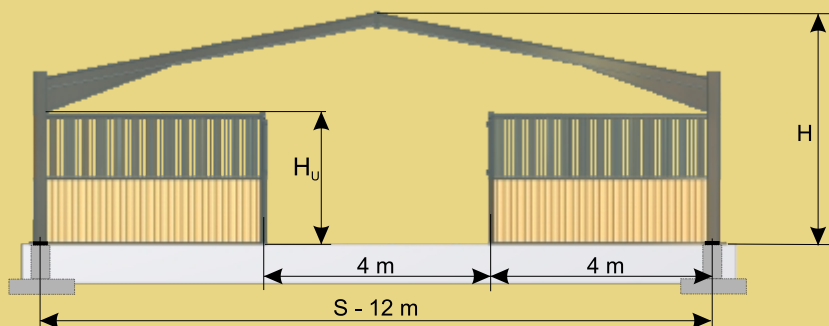

## Ujeżdżalnie okrągłe



**ROLSTAL Pawłowski sp. z o.o.**  
**07-300 Ostrów Mazowiecka**  
**ul. Różańska 45**  
**tel. (029) 645 74 00**  
**fax (029) 645 74 70**  
**e-mail: [konie@rolstal.pl](mailto:konie@rolstal.pl)**

### Transport

Zapewniamy dostawę konstrukcji stalowych na plac budowy własnym transportem samochodowym.

